

GEO

DINING COLLECTION

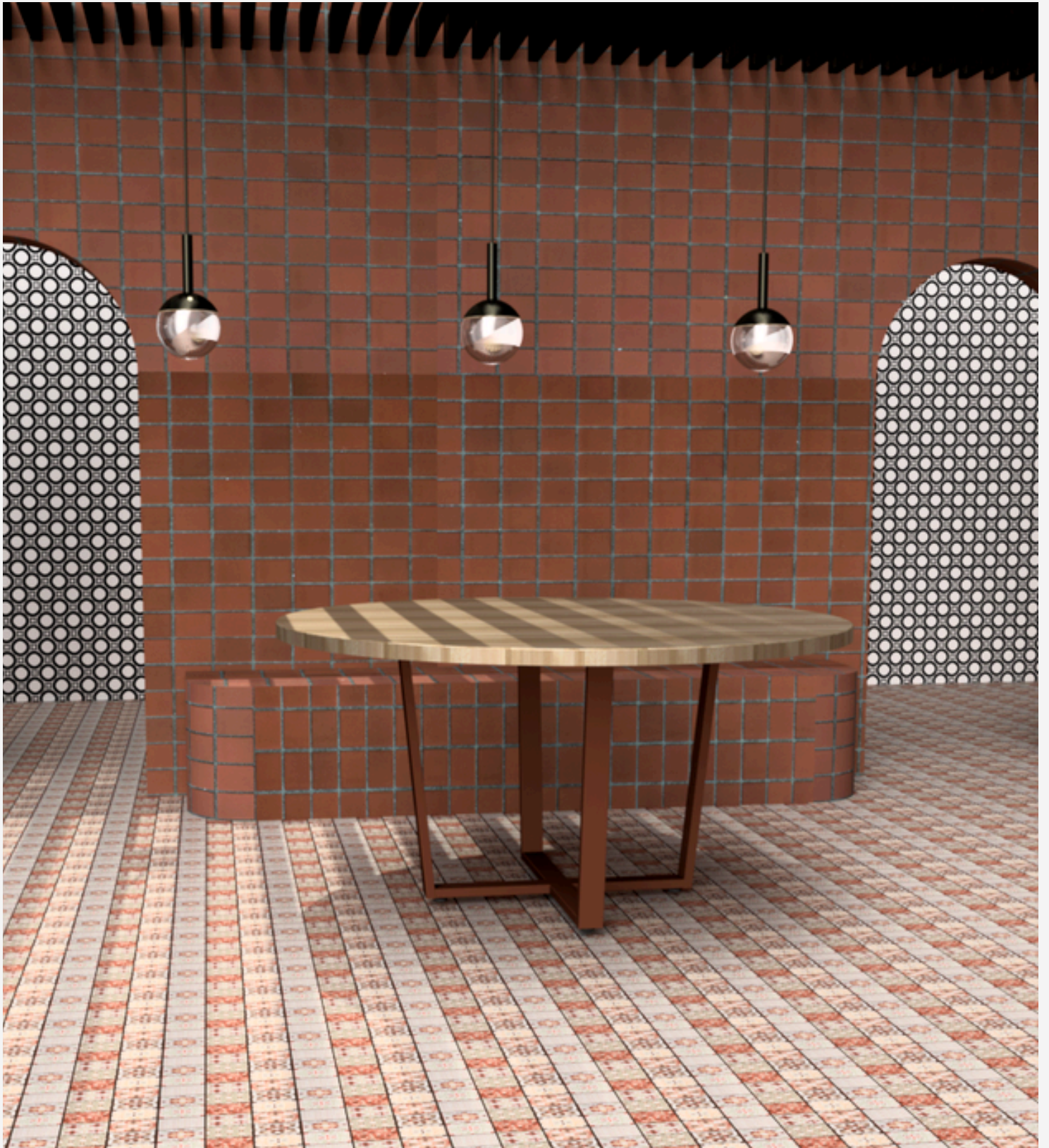

STUDIO WISE



GEO GO-P24

24-36" WIDTHS
24-36" LENGTH"



GEO GO-P36

36-60" WIDTHS
36-60" LENGTH"



GEO GO-E24

24-30" WIDTHS
48-84" LENGTH"



GEO GO-E36

36-42" WIDTHS
48-84" LENGTH"

GEO

EXTERIOR SLAT



STUDIO WISE



GO-EXT-TEAK

24-36" WIDTHS
24-36" LENGTH"



GO-EXT-CYPRESS

36-60" WIDTHS
36-60" LENGTH"

GEO

MOBILE COLLECTION



STUDIO WISE

MOBILE COLLECTION



G E O G O C - E 2 4

24-30" WIDTHS
48-84" LENGTH"



G E O G O C - E 3 6

36-42" WIDTHS
48-84" LENGTH"



G E O G O C - E 2 4 - F L P

24-30" WIDTHS
48-84" LENGTH"



G E O G O C - E 3 6 - F L P

36-42" WIDTHS
48-84" LENGTH"

MOBILE COLLECTION

FEATURES:



SITTING HEIGHT (NOT AVAILABLE IN COUNTER OR BAR HEIGHTS)

INCLUDES 500 LB CAPACITY CASTER WITH BALL BEARING ROLLERS FOR SMOOTH QUIET ROLLING AND LOCKING FOOT LEVER

ASSEMBLES IN MINUTES

ACCESSORIES:



STANDARD-LOCKING CASTER



UPGRADE-FLIP POWER FOR RECTANGLE

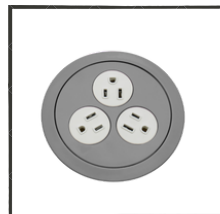

UPGRADE-ROLL POWER FOR PEDESTALS



WHITE



SILVER

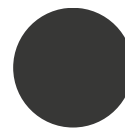

BLACK

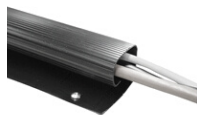

STANDARD-WIRE CHASE



UPGRADE-SURFACE CONNECTOR

GEO

DESK COLLECTION

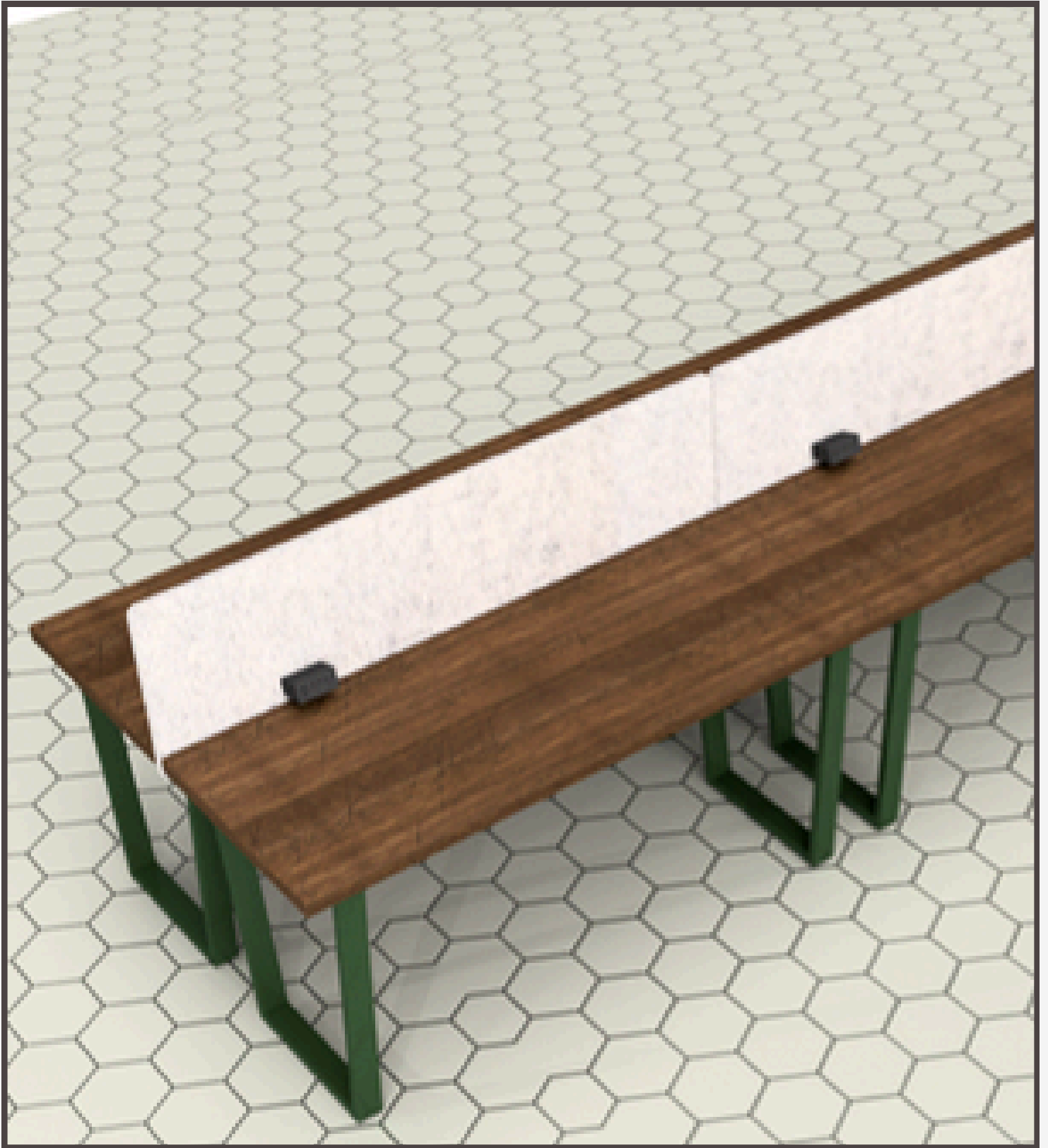

STUDIO WISE

DESK COLLECTION



G E O G O D

24-30" WIDTHS
48-84" LENGTH"

DESK COLLECTION



FEATURES:

- 24" DEEP WORKSURFACE
- AVAILABLE IN 48, 60, 72" LENGTHS
- STANDARD SITTING HEIGHT (NOT AVAILABLE IN COUNTER OR STANDING HEIGHTS)
- INCLUDES DEAN DESKTOP DUPLEX POWER/USB UNIT WITH 72" CORD
- 6MM ZINTRA TACKABLE ACCOUSTIC PANEL
- UNDERSURFACE WIRE MANAGEMENT- DOES NOT INCLUDE ROUTING THROUGH LEG
- LEVELING FEET
- ASSEMBLES IN MINUTES

ACCESSORIES:



STANDARD-1POWER 2USB



WHITE GREY BLACK



STANDARD-12MM ZINTRA PANEL



WHITE GREIGE GREY ASH POSH

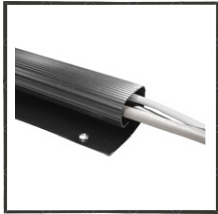

STANDARD-WIRE CHASE



UPGRADE-LOCKING CASTER



UPGRADE-SURFACE CONNECTOR

GEO

TEAM COLLECTION

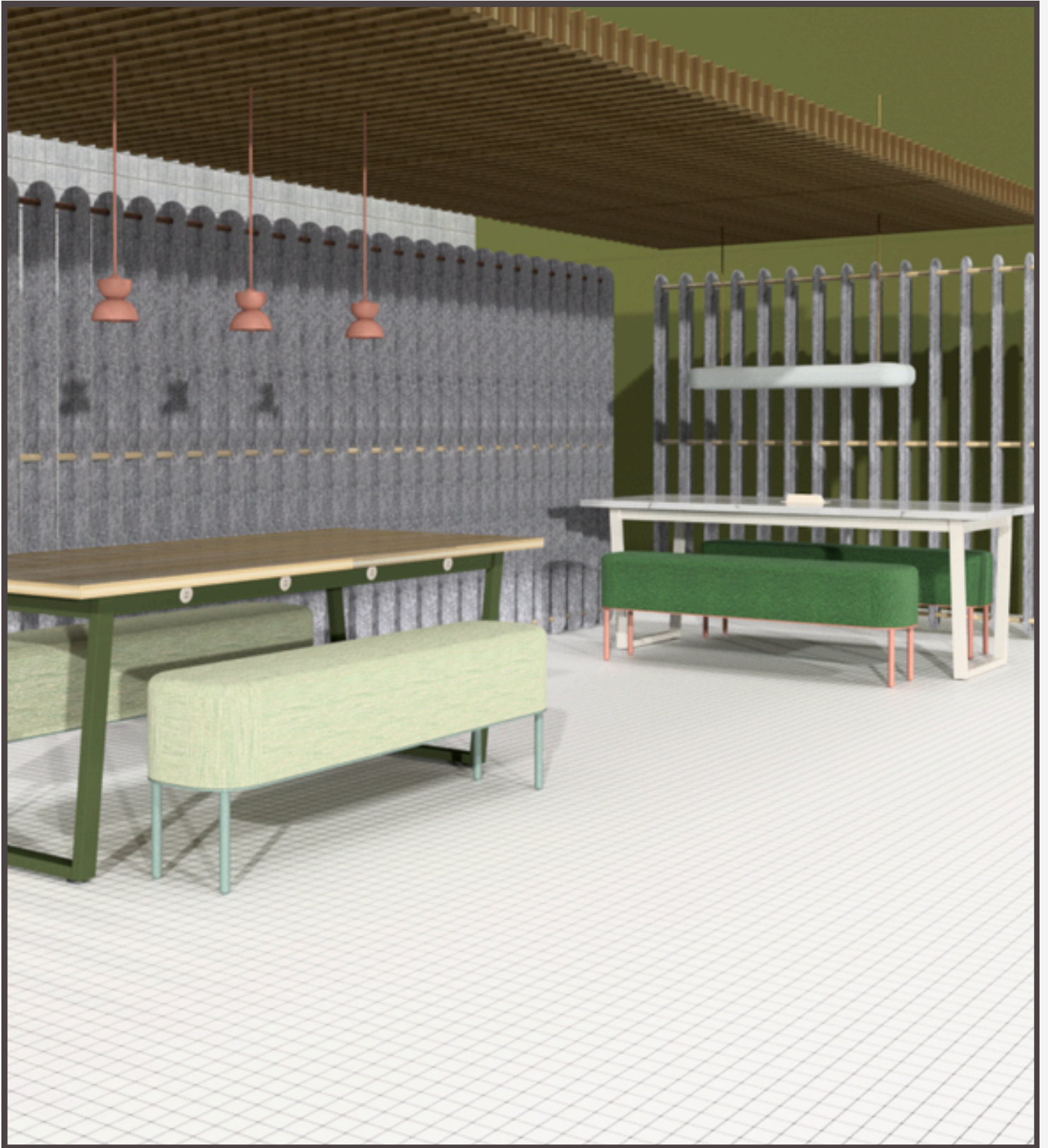

STUDIO WISE

TEAM COLLECTION



RECHARGE - E 2 4

24-36" WIDTHS
60-96" LENGTH"



RECHARGE - E 3 6

36-48" WIDTHS
60-96" LENGTH"



CONNECT - E 2 4

24-36" WIDTHS
60-96" LENGTH"



CONNECT - E 3 6

36-48" WIDTHS
60-96" LENGTH"



TEAM - E 2 4

24-36" WIDTHS
60-96" LENGTH"



TEAM - E 3 6

36-48" WIDTHS
60-96" LENGTH"



FEATURES:

CHOOSE FROM SITTING ,COUNTER AND
STANDING HEIGHT BASE
RIDGED STEEL FRAME WITH WIRE
MANAGEMENT AND ROUTING THROUGH ALL
LEGS.

DOT POWER OR USB CONFIGURED TO
PROVIDE 1 POWER FOR EVERY TWO SEATS.

ASSEMBLES IN MINUTES

ACCESSORIES:



DOT-POWER OPTION



DOT-USB OPTION



WHITE

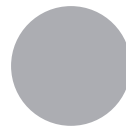

SILVER

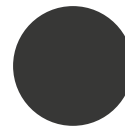

BLACK



STANDARD-WIRE CHASE



UPGRADE 4 OUTLET POWER



UPGRADE-SURFACE CONNECTOR



UPGRADED-LOCKING
CASTER



FEATURES:

CHOOSE FROM SITTING ,COUNTER AND
STANDING HEIGHT BASE (STANDING HEIGHT
NOT AVAILABLE ON TABLES UNDER 36"
WIDTH)
RIDGED STEEL FRAME WITH WIRE
MANAGEMENT AND ROUTING THROUGH ALL
LEGS.
INSURFACE POWER CONFIGURED TO
PROVIDE 1 POWER FOR EVERY TWO SEATS
(.see our full power data collection for more
options)
ASSEMBLES IN MINUTES

ACCESSORIES:



STANDARD-FLIP
POWER



WHITE



SILVER

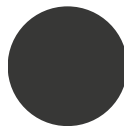

BLACK



4 OUTLET POWER STANDARD
ON LENGTHS OVER 72"



STANDARD-WIRE CHASE

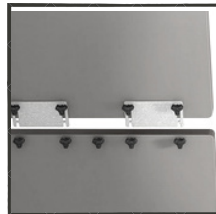

UPGRADE-SURFACE CONNECTOR



UPGRADE-LOCKING CASTER

FUSE

BUTCHERBLOCK SURFACES



STUDIO WISE

FUSE

SHAPES + PROFILES



PROFILES



CUT OUTS

- POWER
- GROMMET

THICKNESS

- 1.5"

FUSE

WOOD FINISHES



FUSE

LASTING QUALITY



WATER
RESISTANT

UV
RESISTANT

STAIN
RESISTANT

OUR FUSE PREMIUM HARDWOOD SURFACES BRING WARMTH AND LASTING BEAUTY TO ANY PROJECT. OUR ARTISANS START WITH SELECT GRADE HARDWOOD FOR PREMIUM APPEARANCE AND STABILITY, THEN OUR WE ENHANCE THE NATURAL GRAINS WITH COLOR WASHES OR ONE OF OUR SIGNATURE DISTRESSING TECHNIQUES.

WE TOP IT OFF WITH 3 COATS OF HOSPITALITY GRADE CLEAR FINISH TO INSURE YOUR SURFACE LOOKS BEAUTIFUL FOR YEARS TO COME..

POP

EXTERIOR SURFACES

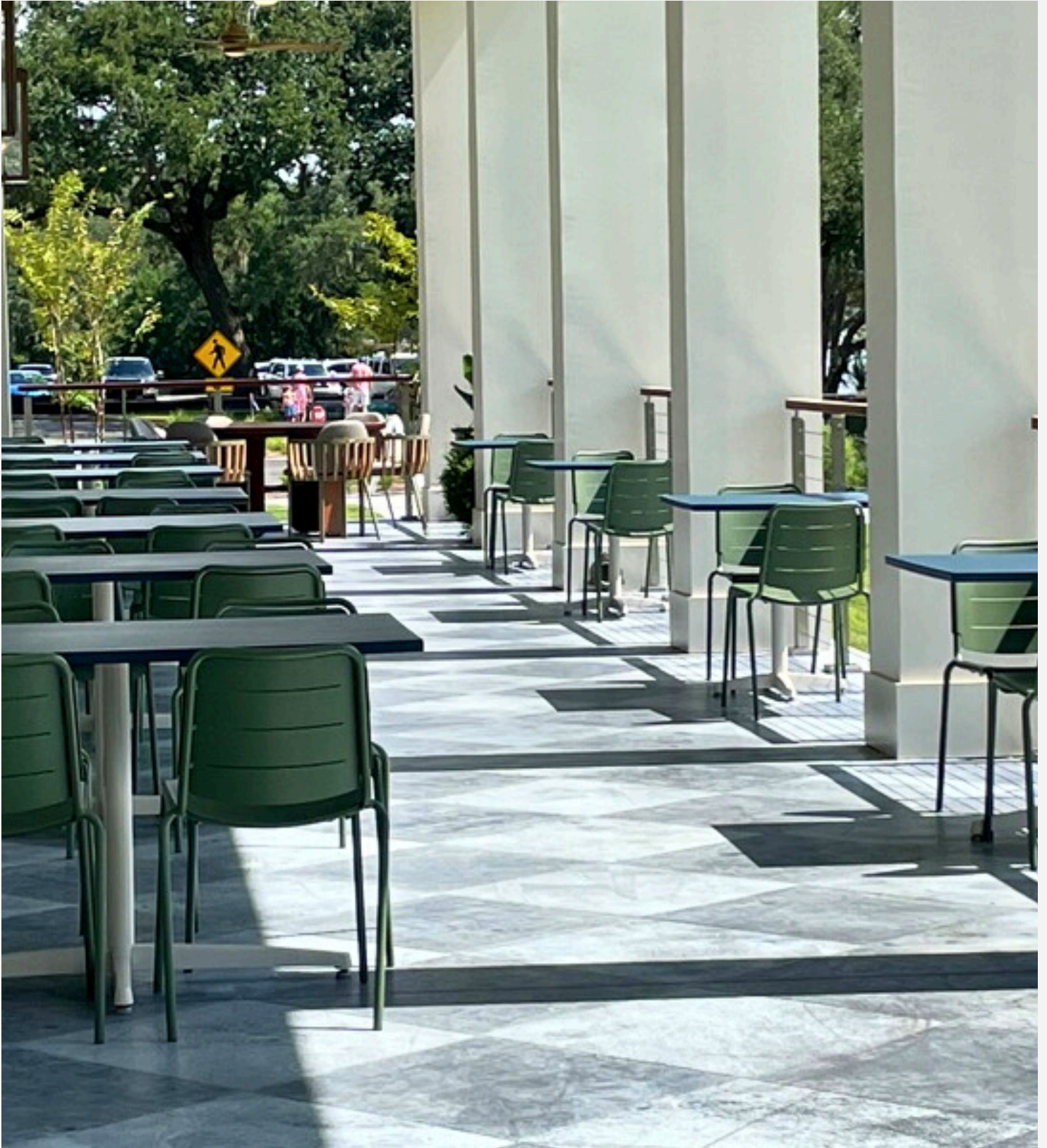

STUDIO WISE

FUSE

SHAPES + PROFILES

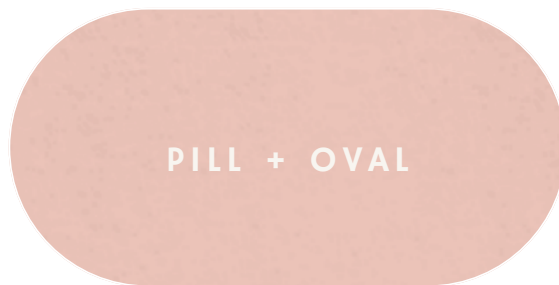
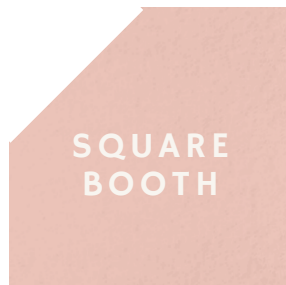

PROFILES



CUT OUTS

- UMBRELLA HOLES
- POWER
- GROMMET

THICKNESS

- 1"

POP

SHAPES + PROFILES



POP

SHAPES + PROFILES

POP surfaces offer the design flexibility and price point you need when compared to laminate or melamine surfaces.

Our wood powdercoat technology provides a 360 degree coating that is completely seamless and doesn't require edge banding, making it the perfect solution for health care, corporate, and hospitality

POP
\$21 SQ FT

MELAMINE
\$33 SQ FT

PLAM
\$39 SQ FT

ATTRIBUTE	STANDRARD TEST	POP	MELAMINE	HIGH PRESSURE LAMINATE
WATER SUBMERSION	NEMA LD3-2005.3.4	No effect	Delamination	Delamination
STAIN RESISTANCE	NEMA LD3-2005.3.4	All reagants no effect	Reagent 1-10 no e ect Reagent 11-15 slight e ect	Reagent 1-10 no e ect Reagent 11-15 slight e ect
SCRATCH HARDNESS	ASTM D3363-05	Meets or exceeds Pass 3H & Pass 4H dependent on formulation	Meets or exceeds 400 cycles	Meets or exceeds 400 cycles
ABRASION RESISTANCE	Tabor Scale- CS-10 wheels, 1000 cycles	60 mg loss	55 mg loss	52 mg loss
CROSSHATCH ADHESION	ASTM D 3359, Methoda	No loss of adhesion	Delamination	Delamination
EDGE PROFILE	Available profiles Availability Comparison	Any	Limited to edge band requirements	Limited to edge band requirements
COLOR CAPABILITY	Availability Comparison	Any color on the spectrum	Limited to MFR o ering	Limited to MFR o ering
VOC'S RELEASED IN PRODUCTION	VOC Release Measurement	Zero	Adhesive o -gas measurement	Adhesive o -gas measurement
RECYCLABILITY	Able to be converted post consumption	Yes - 100%	No	No - phenolic
CARBON FOOTPRINT	KG CO2 per cubic meter	1.5	Much higher	Much higher

QUARTZ

LUXURY SURFACES

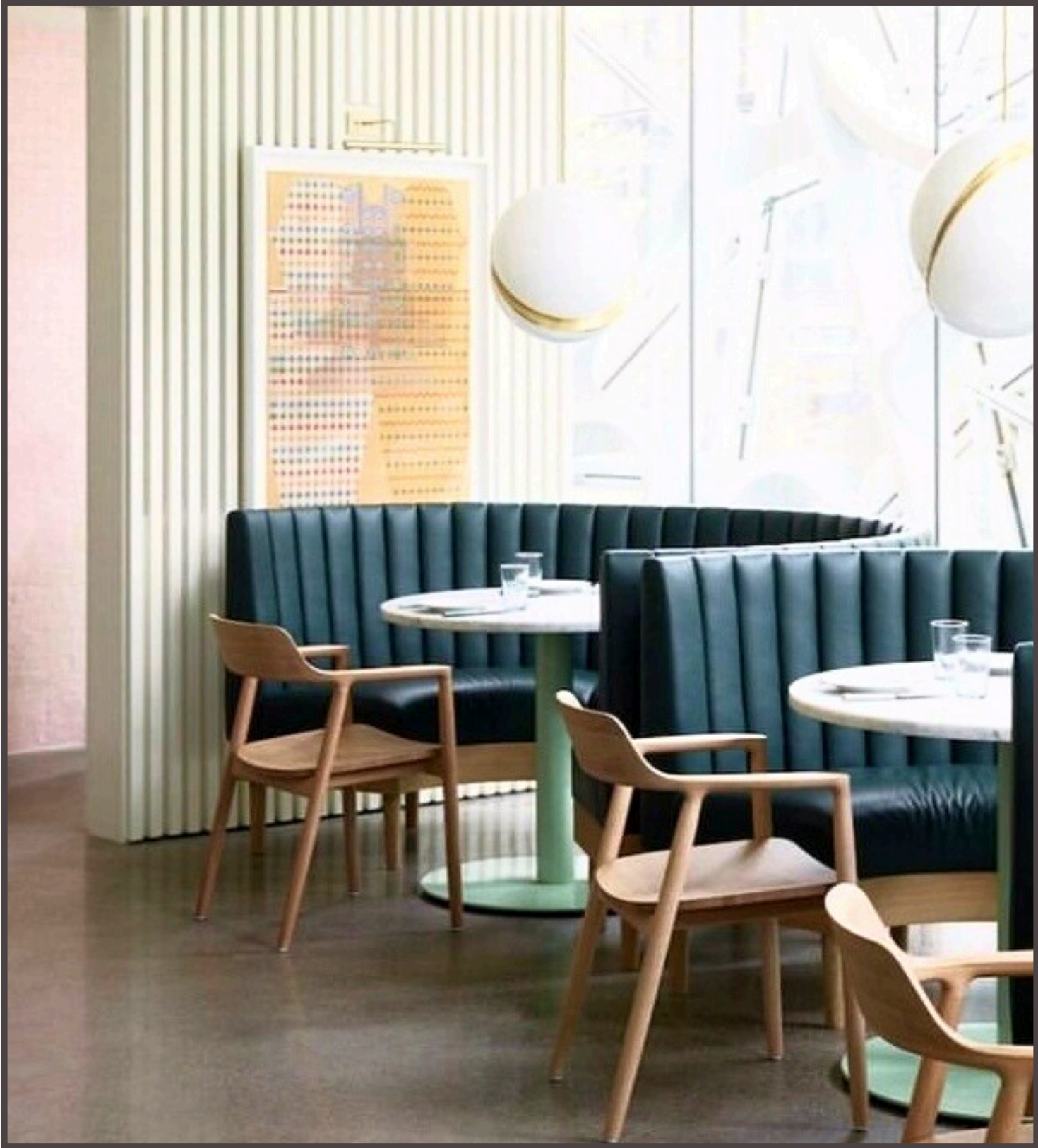

STUDIO WISE

QUARTZ

SHAPES + PROFILES

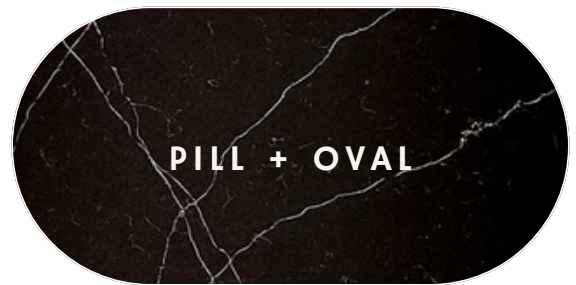

PROFILES



STANDARD

CUT OUTS

- POWER
- GROMMET



THICKNESS

- 3 CM = 1.0625"

QUARTZ

LUXURY FINISHES



QUARTZ

LUXURY FINISHES

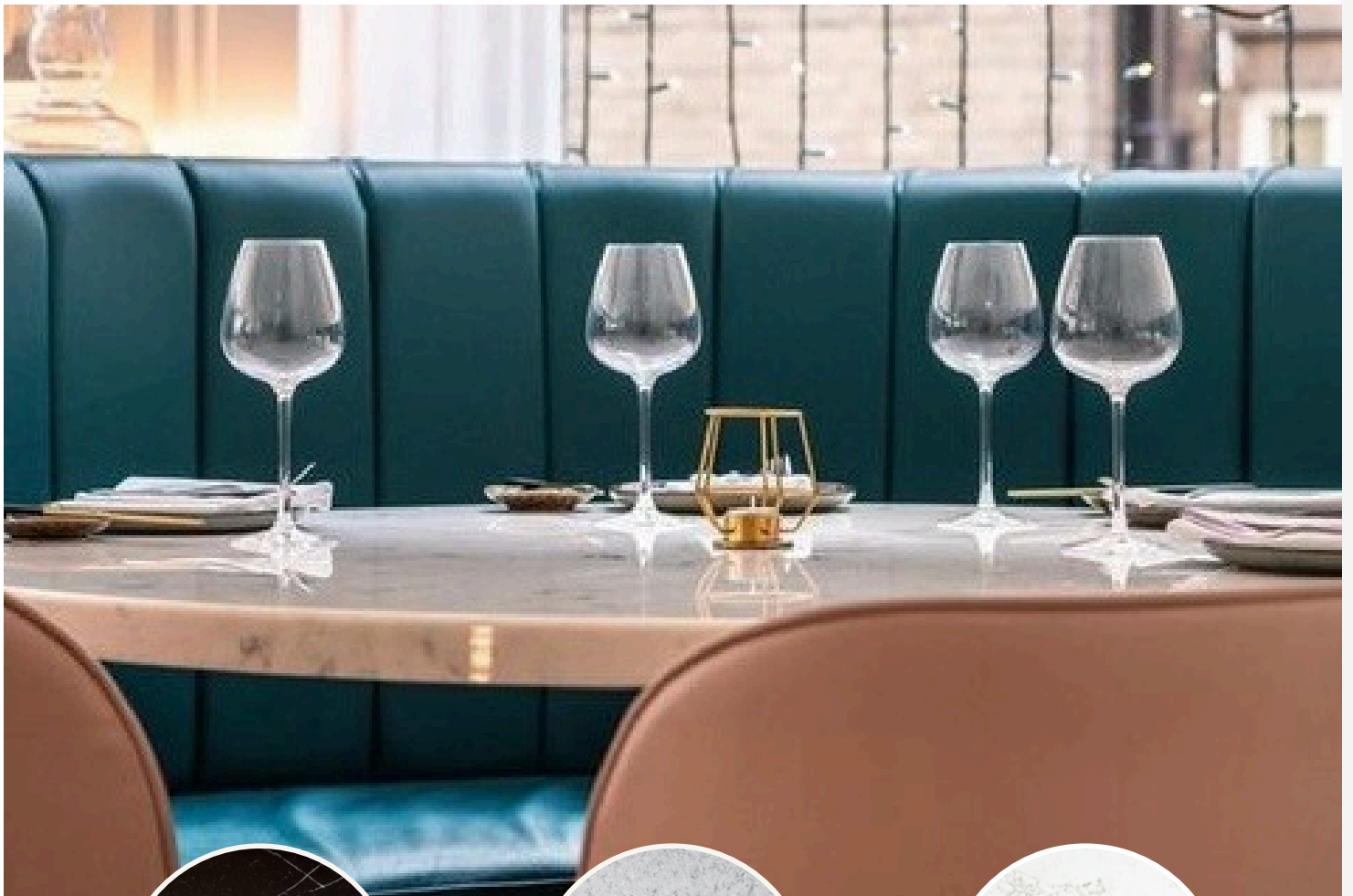

WATER
RESISTANT

UV
RESISTANT

STAIN
RESISTANT

OUR QUARTZ AND STONE SURFACES BRING WARMTH AND CLASSIC STYLE TO ANY PROJECT. OUR CURATED COLLECTION OF FINISHES IS SELECTED OUT OF THE TOP 20 NATIONAL BEST SELLERS TO INSURE YOUR PROJECT IS ALWAYS ON TREND.

FLIP

POWER + DATA

OVERVIEW

Retractable and durably constructed, Flip is highly functional with a fluid, one-touch door that remains open during use. Flip offers a completely scalable solution - from 2 to 8 windows - with a variety of power options and data configurations.

STANDARD ON:

- MOBILE (RECTANGLE)
- TEAM (CONNECT)
- CONFERENCE

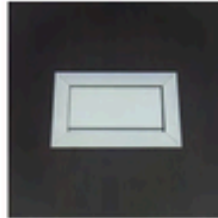

*Image shown: 2 Power, 1 USB with Clear Anodized Aluminum, silver frame plastic and black simplex

STANDARD CONFIGURATION

2 Window_2 Power_Clear Anodized Housing_Black Frame_Black Simplex \$175

Contact sales@studiowise.com for pricing on upgrade configurations.

SPECIFICATIONS

- * Images depicts a 2 Power, and 2 open data.
- * Minimum surface depth is 3/8"

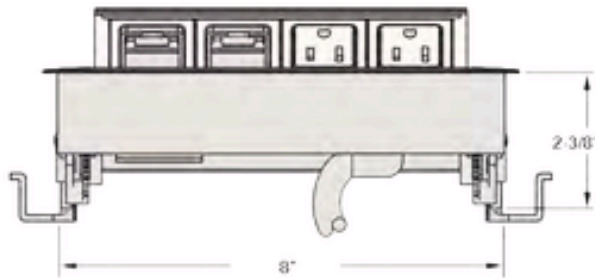
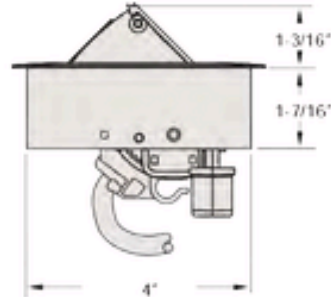
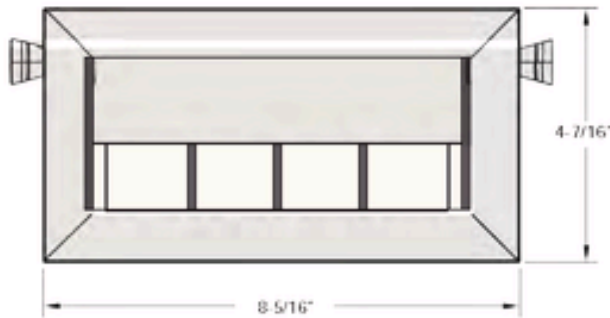

CONFIGURATION SIZING

		LENGTH	WIDTH
Standard	2 Windows	5"	4"
	3 Windows	6-1/2"	4"
Add Options	4 Windows	8"	4"
	5 Windows	9-1/2"	4"
	6 Windows	11"	4"
	7 Windows	12-1/2"	4"
	8 Windows	14"	4"

ROLL

POWER + DATA

OVERVIEW

Roll has a sleek design which allows the product to rotate to open or close to expose or hide the power.

- STANDARD ON:**
- MOBILE (PEDESTAL)
 - TEAM (PEDESTAL)

STANDARD CONFIGURATION

2 Power - 1 USB - Black Housing, Black Simplex \$ 125

Contact sales@studiowisedesign.com for pricing on upgrade configurations.



* Image shown: unit closed

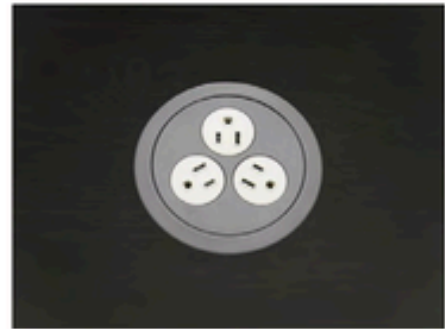

* Image shown: 3 Power Roll

SPECIFICATIONS

* Images depicts a 2 Power and 1 USB unit.

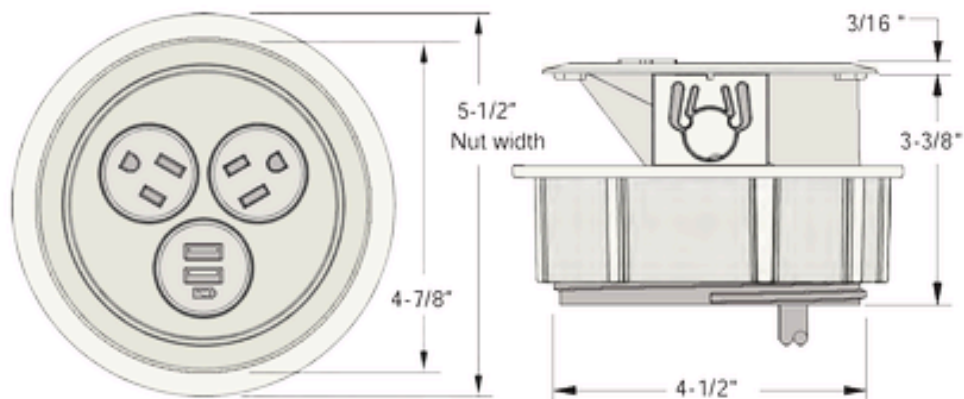

OVERVIEW

DOT is our most compact accessory and features a round or square design and is available in multiple molded plastic and stylish metal-plated finishes. Dot is available with a spill-proof power simplex, USB, HDMI, or a variety of other Networking Cable options. Dot is also offered in a grommet version for discrete data pass through.

STANDARD ON:
TEAM (RECHARGE)

STANDARD CONFIGURATION

Round or Square Power_Black	\$ 35
Round or Square Data_Black	\$ 85

Contact sales@studiowise-design.com for pricing on upgrade configurations.



* image shown: DOT Round USB



* image shown: DOT Square Power

SPECIFICATIONS

