

# ELEMENTS

DINING COLLECTION



STUDIO WISE

DINING COLLECTION



ELEMENTS ELD - P 2 2

24-36" WIDTHS  
24-36" LENGTH"



ELEMENTS ELD - P 2 8

36-54" WIDTHS  
36-54" LENGTH"



ELEMENTS ELD - P 2 2

24-30" WIDTHS  
48-84" LENGTH"



ELEMENTS ELD - P 2 8

36-42" WIDTHS  
48-84" LENGTH"

# ELEMENTS

DINING COLLECTION



STUDIO WISE

DINING COLLECTION



ELEMENTS ELX - P 2 2

24-36" WIDTHS  
24-36" LENGTH"



ELEMENTS ELX - P 2 8

36-54" WIDTHS  
36-54" LENGTH"



ELEMENTS ELX - P 2 2

24-30" WIDTHS  
48-84" LENGTH"



ELEMENTS ELX - P 2 8

36-42" WIDTHS  
48-84" LENGTH"

# FUSE

BUTCHERBLOCK SURFACES

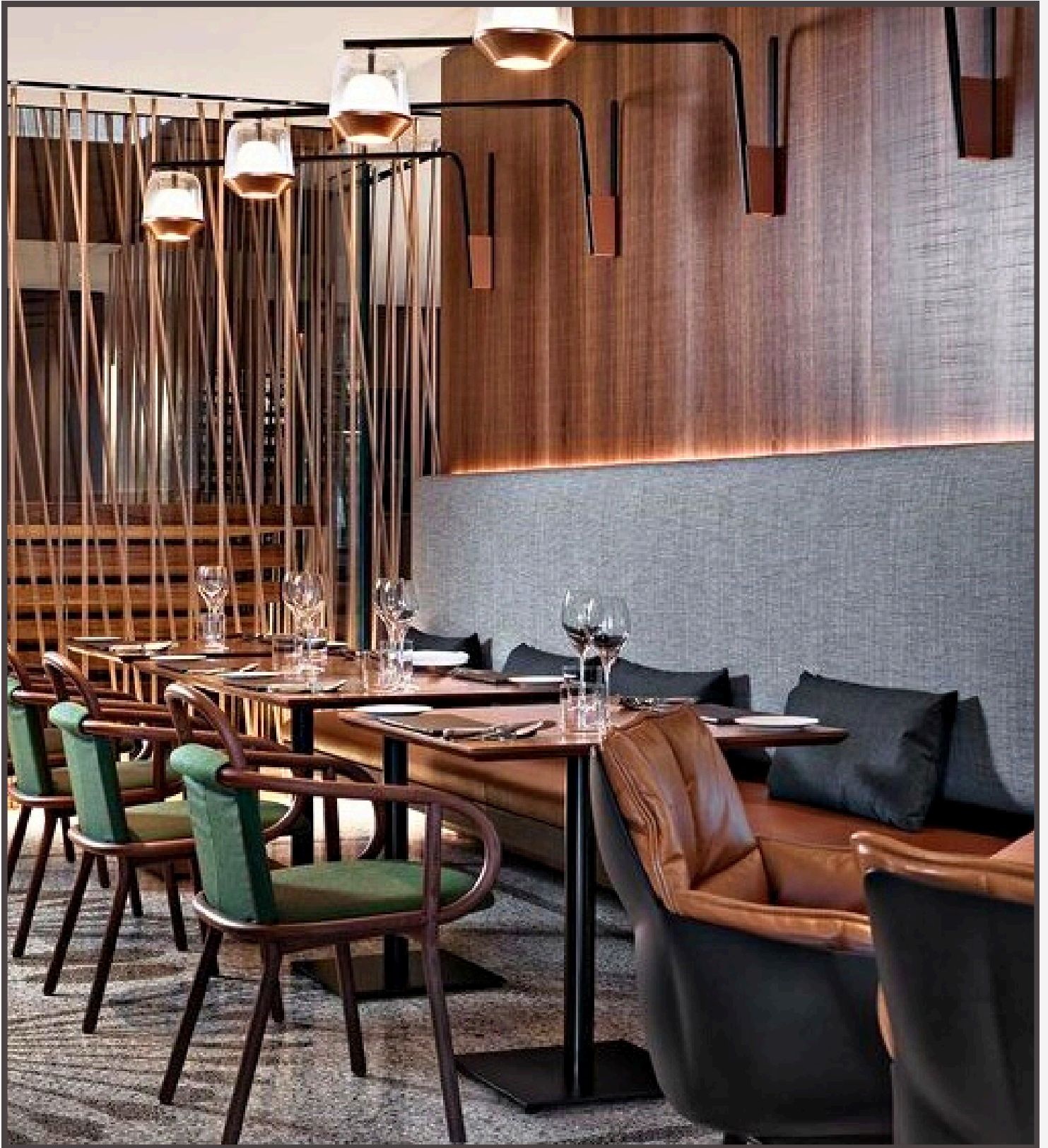

STUDIO WISE

# FUSE

## SHAPES + PROFILES



### PROFILES

---



### CUT OUTS

---

- POWER
- GROMMET

### THICKNESS

---

- 1.5"

# FUSE

## WOOD FINISHES



# FUSE

LASTING QUALITY



WATER  
RESISTANT

UV  
RESISTANT

STAIN  
RESISTANT

OUR FUSE PREMIUM HARDWOOD SURFACES BRING WARMTH AND LASTING BEAUTY TO ANY PROJECT. OUR ARTISANS START WITH SELECT GRADE HARDWOOD FOR PREMIUM APPEARANCE AND STABILITY, THEN OUR WE ENHANCE THE NATURAL GRAINS WITH COLOR WASHES OR ONE OF OUR SIGNATURE DISTRESSING TECHNIQUES.

WE TOP IT OFF WITH 3 COATS OF HOSPITALITY GRADE CLEAR FINISH TO INSURE YOUR SURFACE LOOKS BEAUTIFUL FOR YEARS TO COME..

# POP

EXTERIOR SURFACES



STUDIO WISE

# FUSE

## SHAPES + PROFILES

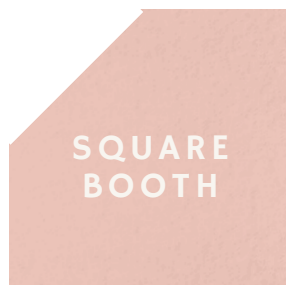

### PROFILES

---



### CUT OUTS

---

- UMBRELLA HOLES
- POWER
- GROMMET

### THICKNESS

---

- 1"

# POP

## SHAPES + PROFILES



# POP

## SHAPES + PROFILES

POP surfaces offer the design flexibility and price point you need when compared to laminate or melamine surfaces.

Our wood powdercoat technology provides a 360 degree coating that is completely seamless and doesn't require edge banding, making it the perfect solution for health care, corporate, and hospitality



ATTRIBUTE	STANDRARD TEST	POP	MELAMINE	HIGH PRESSURE LAMINATE
<b>WATER SUBMERSION</b>	NEMA LD3-2005.3.4	No effect	Delamination	Delamination
<b>STAIN RESISTANCE</b>	NEMA LD3-2005.3.4	All reagants no effect	Reagent 1-10 no effect Reagent 11-15 slight effect	Reagent 1-10 no effect Reagent 11-15 slight effect
<b>SCRATCH HARDNESS</b>	ASTM D3363-05	Meets or exceeds Pass 3H & Pass 4H dependent on formulation	Meets or exceeds 400 cycles	Meets or exceeds 400 cycles
<b>ABRASION RESISTANCE</b>	Tabor Scale- CS-10 wheels, 1000 cycles	60 mg loss	55 mg loss	52 mg loss
<b>CROSSHATCH ADHESION</b>	ASTM D 3359, Method a	No loss of adhesion	Delamination	Delamination
<b>EDGE PROFILE</b>	Available profiles Availability Comparison	Any	Limited to edge band requirements	Limited to edge band requirements
<b>COLOR CAPABILITY</b>	Availability Comparison	Any color on the spectrum	Limited to MFR coloring	Limited to MFR coloring
<b>VOC'S RELEASED IN PRODUCTION</b>	VOC Release Measurement	Zero	Adhesive o -gas measurement	Adhesive o -gas measurement
<b>RECYCLABILITY</b>	Able to be converted post consumption	Yes - 100%	No	No - phenolic
<b>CARBON FOOTPRINT</b>	KG CO2 per cubic meter	1.5	Much higher	Much higher

# QUARTZ

LUXURY SURFACES

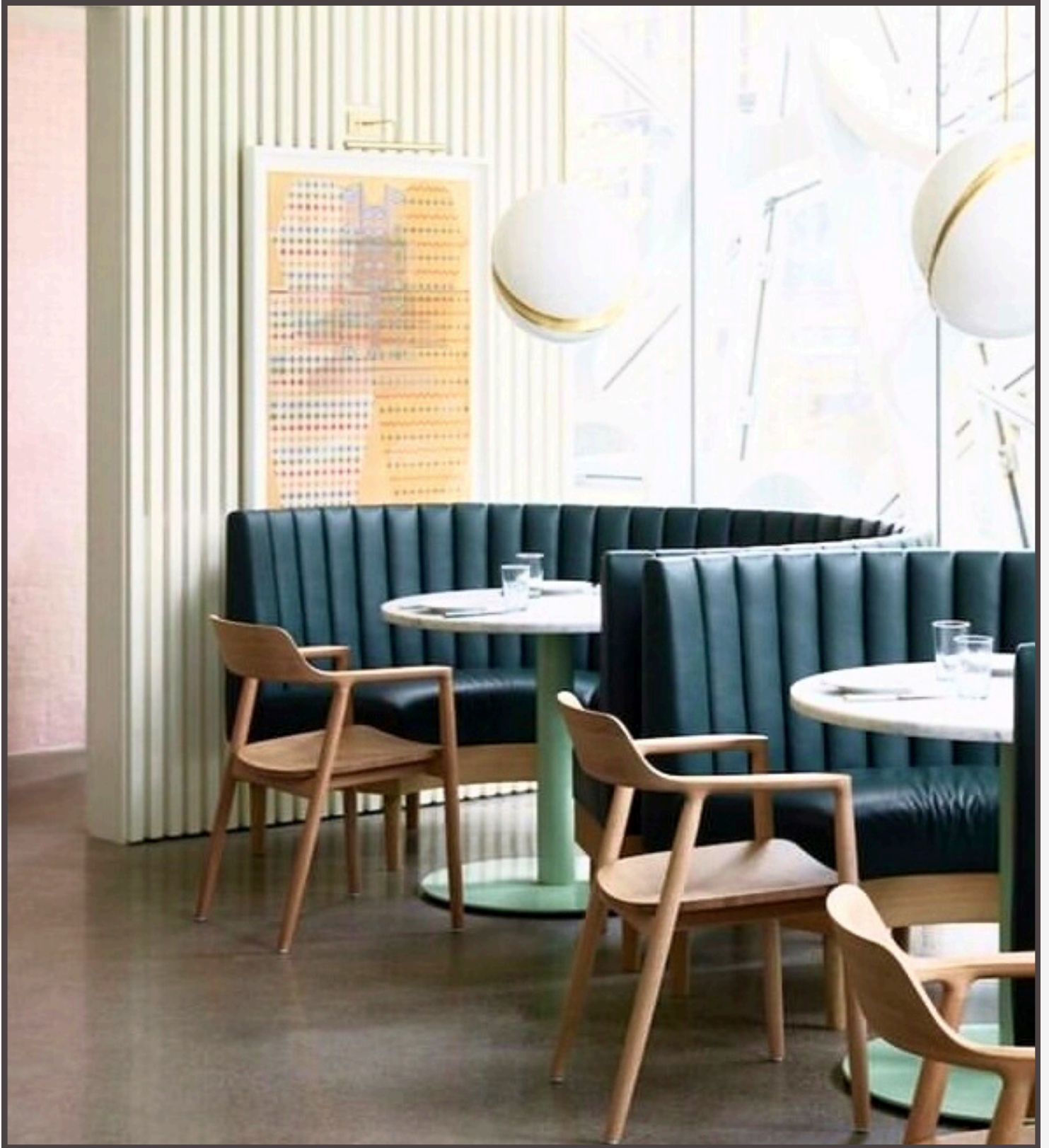

STUDIO WISE

# QUARTZ

## SHAPES + PROFILES



### PROFILES

---



STANDARD

### CUT OUTS

- POWER
- GROMMET



### THICKNESS

---

- 3 CM = 1.0625"

# QUARTZ

LUXURY FINISHES



# QUARTZ

LUXURY FINISHES



WATER  
RESISTANT

UV  
RESISTANT

STAIN  
RESISTANT

OUR QUARTZ AND STONE SURFACES BRING WARMTH AND CLASSIC STYLE TO ANY PROJECT. OUR CURATED COLLECTION OF FINISHES IS SELECTED OUT OF THE TOP 20 NATIONAL BEST SELLERS TO INSURE YOUR PROJECT IS ALWAYS ON TREND.

# FLIP

POWER + DATA

## OVERVIEW

Retractable and durably constructed, Flip is highly functional with a fluid, one-touch door that remains open during use. Flip offers a completely scalable solution - from 2 to 8 windows - with a variety of power options and data configurations.

### STANDARD ON:

- MOBILE (RECTANGLE)
- TEAM (CONNECT)
- CONFERENCE

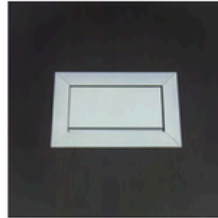

\* image shown: 2 Power, 1 USB with Clear Anodized Aluminum, silver frame plastic and black simplex

## STANDARD CONFIGURATION

2 Window\_2 Power\_Clear Anodized Housing\_Black Frame\_Black Simplex \$175

Contact [sales@studiowisedesign.com](mailto:sales@studiowisedesign.com) for pricing on upgrade configurations.

## SPECIFICATIONS

- \* Images depicts a 2 Power, and 2 open data.
- \* Minimum surface depth is 3/8"

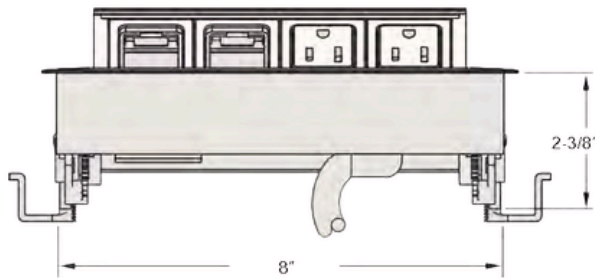
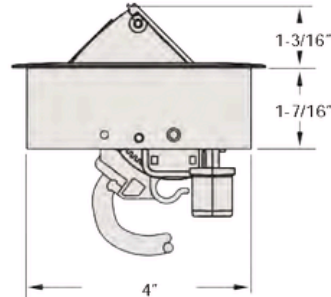
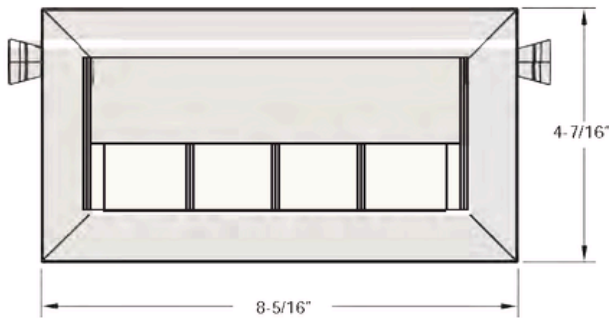

### CONFIGURATION SIZING

		LENGTH	WIDTH
Standard	2 Windows	5"	4"
	3 Windows	6-1/2"	4"
Add Options	4 Windows	8"	4"
	5 Windows	9-1/2"	4"
	6 Windows	11"	4"
	7 Windows	12-1/2"	4"
	8 Windows	14"	4"

## OVERVIEW

Roll has a sleek design which allows the product to rotate to open or close to expose or hide the power.

- STANDARD ON:**
- MOBILE (PEDESTAL)
  - TEAM (PEDESTAL)

## STANDARD CONFIGURATION

2 Power-1 USB - Black Housing, Black Simplex \$ 125

Contact [sales@studiowisedesign.com](mailto:sales@studiowisedesign.com) for pricing on upgrade configurations.



\* image shown: unit closed

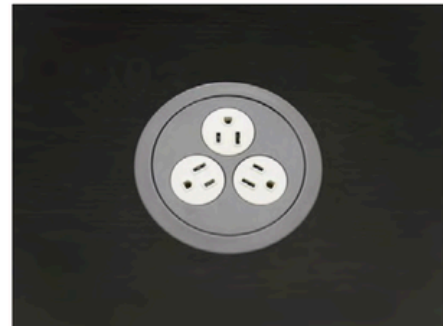

\* Image shown: 3 Power Roll

## SPECIFICATIONS

\* Images depicts a 2 Power and 1 USB unit.

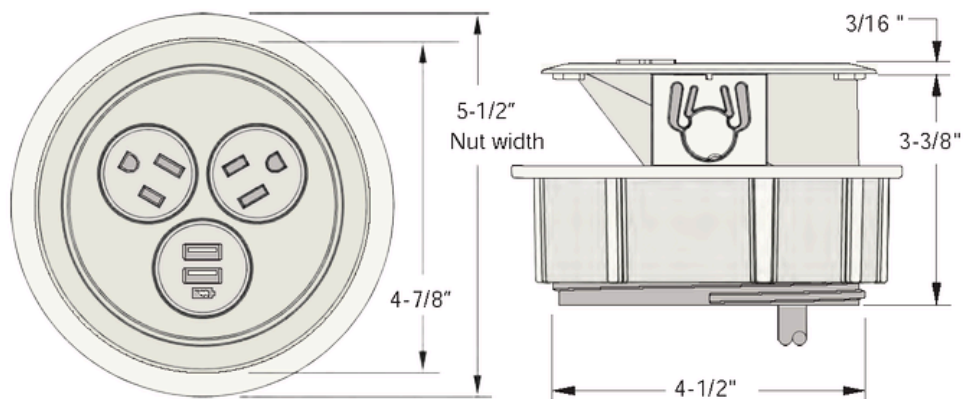

## OVERVIEW

DOT is our most compact accessory and features a round or square design and is available in multiple molded plastic and stylish metal-plated finishes. Dot is available with a spill-proof power simplex, USB, HDMI, or a variety of other Networking Cable options. Dot is also offered in a grommet version for discrete data pass through.

**STANDARD ON:**  
TEAM (RECHARGE)

## STANDARD CONFIGURATION

Round or Square Power_Black	\$ 35
Round or Square Data_Black	\$ 85

Contact [sales@studiowise.design.com](mailto:sales@studiowise.design.com) for pricing on upgrade configurations.

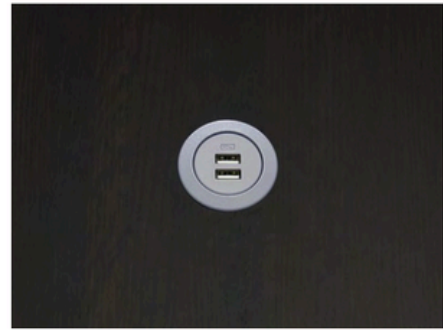

\* image shown: DOT Round USB

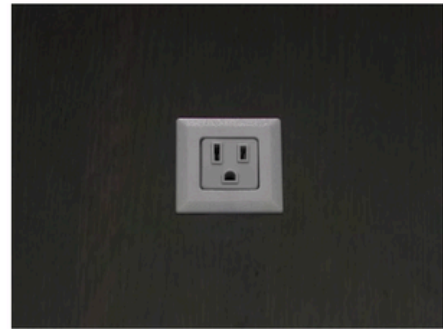

\* image shown: DOT Square Power

## SPECIFICATIONS

